

1- Line Unidirectional ESD Protection Diode

General description

These surge protection diodes are designed for applications requiring transient overvoltage protection capability. They are intended for use in voltage and ESD sensitive equipment such as computers, printers, business machines, communication systems, medical equipment and other applications. These devices are ideal for situations where board space is at a premium.

Features and benefits

- Working Voltage: 5.0V
- Response time is typically < 1 ns
- Low leakage current: nA Level
- IEC 61000-4-2 (ESD Air): ± 30 kV
- IEC 61000-4-2 (ESDContact): ± 30 kV
- IEC61000-4-5(Lightning 8/20 μ S): 25A

Application information

- Power lines
- Microprocessor based equipment
- Personal Digital Assistants (PDA's)
- Notebooks, Desktops, and Servers
- Cell phone Handsets and Accessories
- Portable Electronics

Schematic & Pin configuration

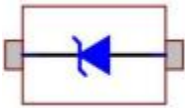
Simplified outline	Graphic symbol
	

Portion Electronics Parameter

Symbol	Parameter
I_{PP}	Reverse Peak Pulse Current
V_C	Clamping Voltage @ I_{PP}
V_{RWM}	Working Peak Reverse Voltage
I_R	Reverse Leakage Current @ V_{RWM}
V_{BR}	Breakdown Voltage @ I_T
I_T	VBR Test Current
I_F	Forward Current
V_F	Forward Voltage @ I_F

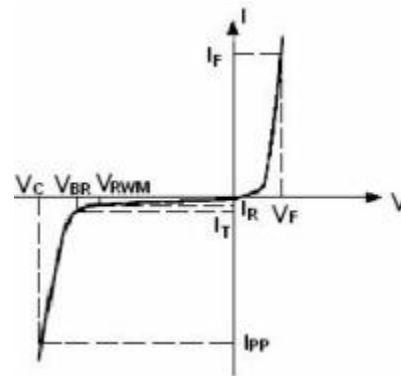

Maximum Ratings

($T_A = 25\text{ }^\circ\text{C}$, unless otherwise specified)

Parameter	Symbol	Value	Unit
Peak Pulse Power ($T_p = 8/20\mu\text{s}$)	P_{PPM}	325	W
Rated Peak Pulse Current ($T_p = 8/20\mu\text{s}$)	I_{PPM}	25	A
ESD voltage IEC 61000-4-2 (air discharge)	V_{ESD}	30	kV
ESD voltage IEC 61000-4-2 (contact discharge)	V_{ESD}	30	kV
Maximum lead temperature for soldering during 10s	T_L	260	$^\circ\text{C}$
Storage Temperature Range	T_{stg}	-55 to +150	$^\circ\text{C}$
Operating Temperature Range	T_J	-40 to +125	$^\circ\text{C}$

Electrical Characteristics

($T_A = 25\text{ }^\circ\text{C}$, unless otherwise specified)

Parameter	Symbol	Min	Typ	Max	Unit	Condition
Reverse Working Voltage	V_{RWM}	--	--	5.0	V	
Breakdown Voltage	V_{BR}	6.5	7.6	8.0	V	$I_T=1\text{mA}$
Leakage Current ILeak	I_R	--	--	100	nA	$V_{RWM}=5.0\text{V}$
Forward Voltage	V_F	0.6	0.8	0.9	V	$I_F=10\text{mA}$
Clamping Voltage	V_C	--	9.0	--	V	$I_{PP}=2\text{A}, T_p=8/20\mu\text{s}$
Clamping Voltage	V_C	--	14.8	16.0	V	$I_{PP}=25\text{A}, T_p=8/20\mu\text{s}$
Junction Capacitance	C_j	--	190	200	pF	$V_R=0\text{V}, f=1\text{MHz}$
Junction Capacitance	C_j	--	87	95	pF	$V_R=5.0\text{V}, f=1\text{MHz}$

Typical Performance Characteristics

($T_A=25^\circ\text{C}$ unless otherwise Specified)

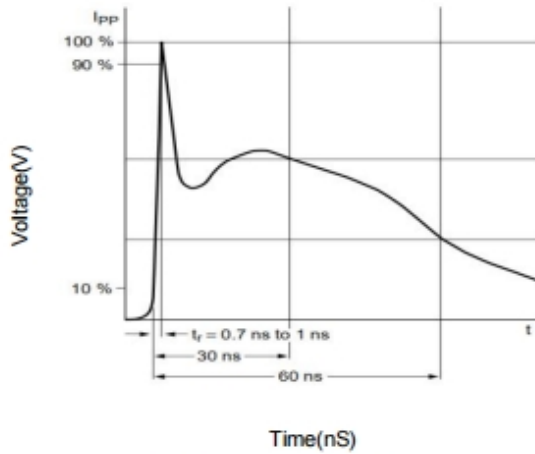

IEC61000-4-2 Pulse Waveform

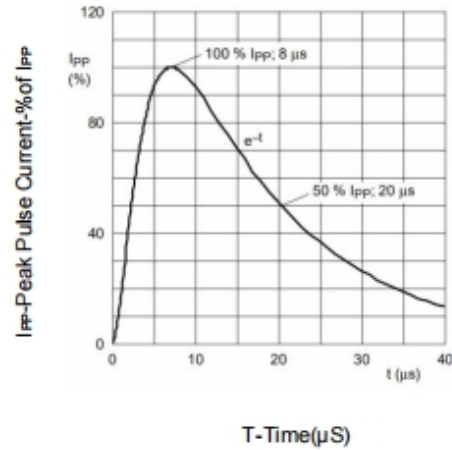

IEC61000-4-5 8X20 μs Pulse Waveform

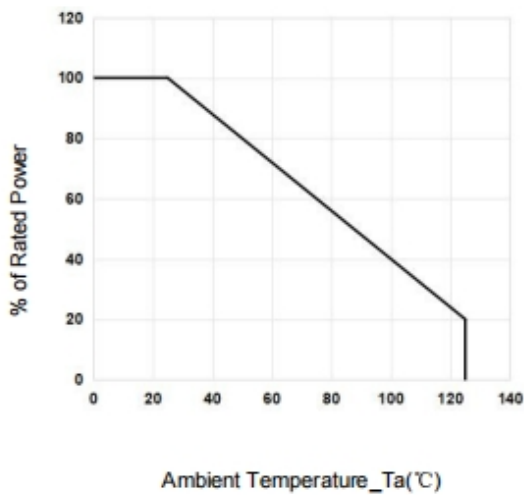

Power Derating Curve

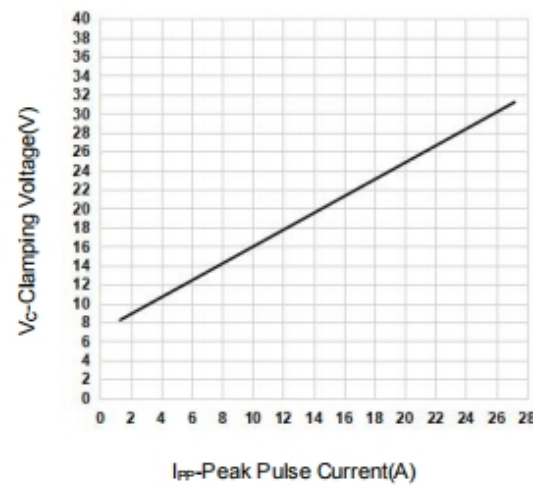

Clamping Voltage vs. Peak Pulse Current

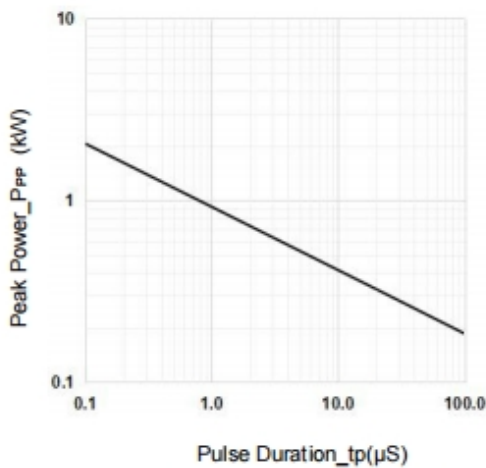

Peak Pulse Power vs. Pulse Time

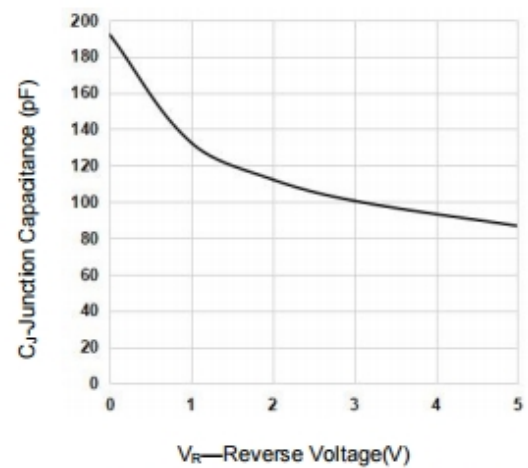

Junction Capacitance vs. Reverse Voltage

Soldering Parameters

Reflow Condition		Pb-Free Assembly
Pre-heat	- Temperature Min ($T_{s(min)}$)	+150°C
	- Temperature Max($T_{s(max)}$)	+200°C
	- Time (Min to Max) (t_s)	60-180 secs.
Average ramp up rate (Liquid us Temp (T_L) to peak)		3°C/sec. Max
$T_{s(max)}$ to T_L - Ramp-up Rate		3°C/sec. Max
Reflow	- Temperature(T_L)(Liquid us)	+217°C
	- Temperature(t_L)	60-150 secs.
Peak Temp (T_p)		+260(+0/-5)°C
Time within 5°C of actual Peak Temp (t_p)		30 secs. Max
Ramp-down Rate		6°C/sec. Max
xTime 25°C to Peak Temp (T_p)		8 min. Max
Do not exceed		+260°C

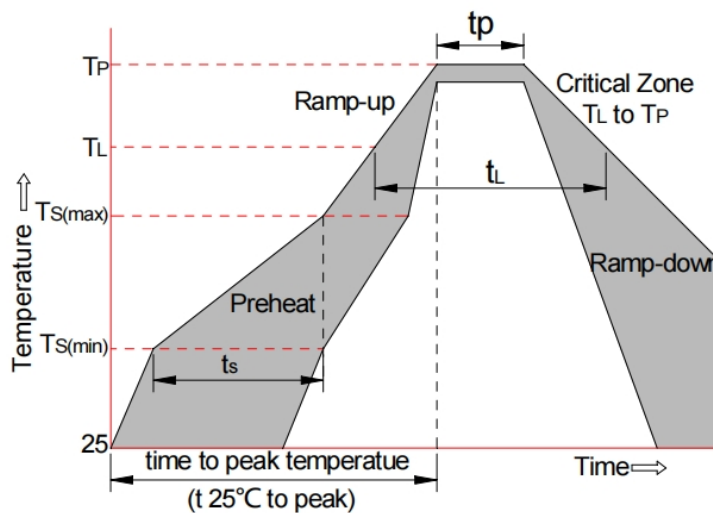

Package Outline Dimensions

SOD323

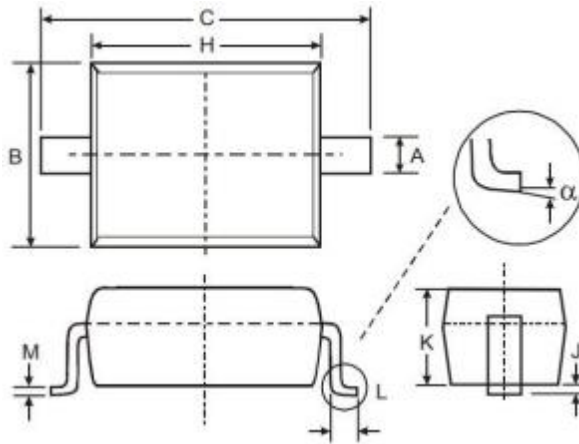

SYMBOL	MILLIMETERS	
	MIN	MAX
A	0.25	0.35
B	1.20	1.40
C	2.40	2.70
H	1.60	1.80
J	0.01	0.15
K	0.70	0.90
L	0.20	0.40
M	0.08	0.15
α	0°	8°

Soldering Footprint (mm)

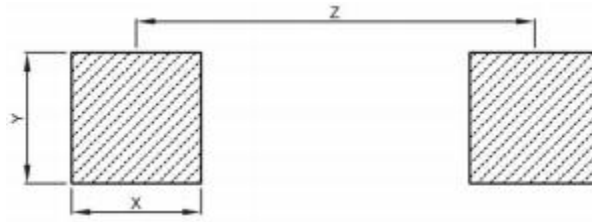

SYMBOL	MILLIMETERS	
	MIN	MAX
X	0.65	0.75
Y	0.65	0.75
Z	2.10	2.20

Ordering information

Package	Reel Size	Packaging (pcs)	Units/InnerBox(pcs)	Units/OuterBox(pcs)
SOD323	7 Inch	3000/Tape & Reel	45000	180000

IMPORTANT NOTICE

Wuxi PWChip Semi Technology CO., LTD (PW) reserves the right to make corrections, modifications, enhancements, improvements, and other changes to its products and services at any time and to discontinue any products or services. Customers should obtain the latest relevant information before placing orders and should verify that such information is current and complete.

PW assumes no liability for applications assistance or customer product design. Customers are responsible for their products and applications using PW components.

PW products are not authorized for use in safety-critical applications (such as life support devices or systems) where a failure of the PW product would reasonably be expected to affect the safety or effectiveness of that devices or systems.

The information included herein is believed to be accurate and reliable. However, PW assumes no responsibility for its use; nor for any infringement of patents or other rights of third parties which may result from its use.